

CGL/CGH

Horizontal, External Gear Pumps with Built-in Relief Valve for Cargo

황축, 외치차 기어펌프 안전변 내장식, 화물이송용

200m³/h ×~10kg

용도 및 적용 분야 / Use and applications

01. 용도 : 일반중유, 맑은 액체, 당밀 등
02. 사용압력 : 최고 10kg/cm², 상용 7.5g/cm²
03. 베어링 : 로울러 베어링을 사용하며 그리스 윤활을 한다.
04. 축씰일링 : 오일 씰 또는 메카니칼 씰을 장착하며, 필요한 경우 축슬리브를 장착한다.
05. 안전변 : 안전변은 펌프와 배관 또는 부속기의 파손 방지를 위해서 펌프의 상부에 내장되어 있으며, 안전변에 걸리는 압력이 적고 떨림 현상이 발생하지 않는 것이 특징이다.
06. 플랜지 : KS 또는 JIS 10kg/cm²급 (FF)

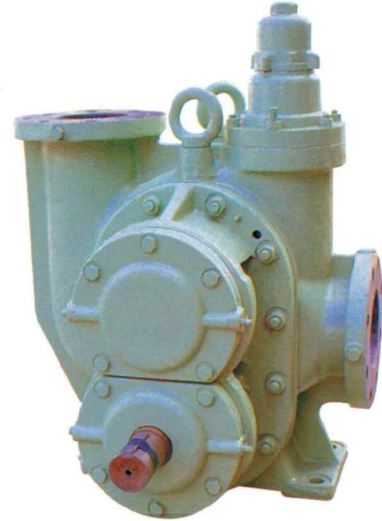

01. Application : Heavy oil, Clean liquid, Molasses etc.
02. Differential pressure : Up to 10kg/cm²
03. Bearing : Roller bearing, lubricated by grease.
04. Shaft sealing : oil seal or mechanical seal.
Shaft sleeve available.
05. Relief valve : Built-in type.
06. Flanges : Suction and delivery
KS or JIS 10kg/cm² rating (FF)

TYPE	BORE(mm)		OPERATING DATE		SHAFT SEALING SIZE		BEARING NO.	FLANGE POSITION		WEIGHT (KG)	ROTATION
	SUC.	DIS	RPM	CAPACITY(m ³ /hr)	OIL SEAL	M.SEAL(UBA)		SUC.	DIS		
CGH 60	Ø 100	Ø 100	850	60	D65 D88 T12	Ø 65	#21310	SIDE	SIDE	200	C.W/ C.C.W
CGL 120	Ø 125	Ø 125	650	120	D80 D105 T13	Ø 80	#21313	SIDE	TOP	470	
CGH120									SIDE	450	
CGL 150	Ø 150	Ø 150	600	150	D85 D110 T13	Ø 85	#21314	SIDE	TOP	670	
CGH 150									SIDE	625	
CGL 200	Ø 175	Ø 175	550	200	D95 D120 T13	Ø 95	#21316	SIDE	TOP	730	
CGH 200									SIDE	655	

선정표(60Hz) / General performance selection chart (60Hz)

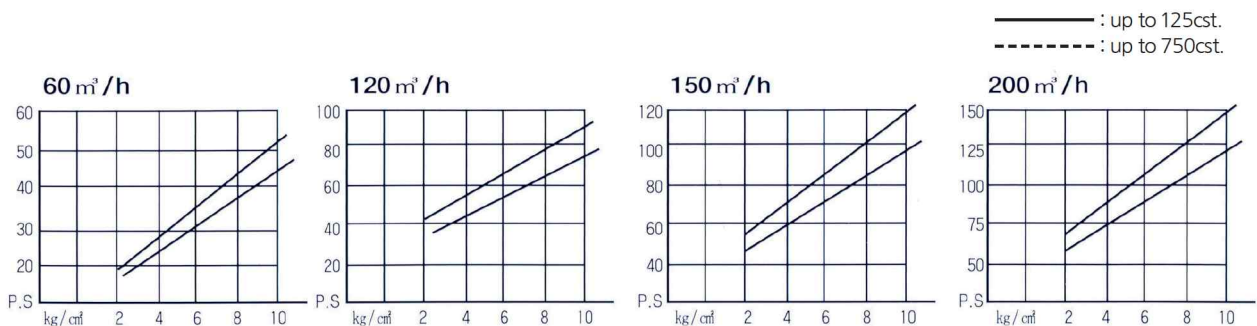

조립 단면도 / Sectional drawing

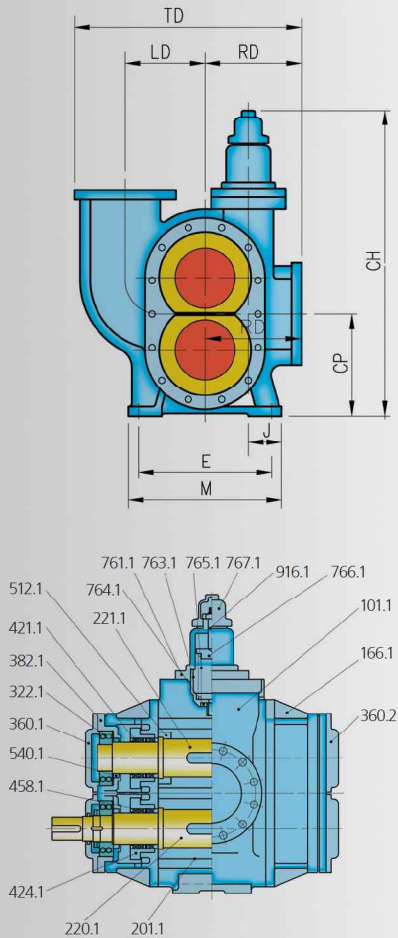

NO.	PART NAME	MATERIAL		Q'ty
		GLASS 1	GLASS 2	
101.1	PUMP CASING	GC 200	GCD 450	1
166.1	SIDE COVER(INNER)	GC 200	GCD 450	2
201.1	GEAR	GCD 450		2
220.1	DRIVE SHAFT	SM 45C		1
221.1	DRIVEN SHAFT	SM 45C		1
322.1	ROLLER BEARING	STB 2		4
360.1	BEARING COVER(INNER)	GC 200		1
360.2	BEARING COVER(OUTER)	GC 200		3
382.1	BEARING CASE	GC 200		4
421.1	OIL SEAL	NBR		16
424.1	SEAL CASE	GC 200		4
458.1	LANTERN RING	SS 400		4
512.1	GEAR SET RING	SM 45C		2
540.1	BUSH	STS 304		1
761.1	VALVE SEAT	GC 200	GCD 450	1
763.1	SAFETY VALVE	SSC 13		1
764.1	VALVE SEAT	STS 410J1		1
765.1	VALVE SPRING	SPS 6		1
766.1	SPRING CARRIER	SS 400		1
767.1	VALVE CAP	GC 200		1
916.1	ADJUSTING SCREW	SS 400		1

CGL/CGH

외형치수도 / Outline dimensions

TYPE	PUMP DIMENTION (mm)																			
	A	R	L	CL	CH	CP	CK	I	G	J	E	M	F	N	Z	RD	LD	TD	EP	MA
CGL120	315	515	830	170	349	260	600	761	24	85	370	430	140	190	4-Ø24	265	200	590	300	460
CGH120							-										-			
CGL150	340	545	885	180	377	279	630	829	28	90	380	440	180	240	4-Ø24	275	210	625	80	300
CGH150							-										-			
CGL200	380	585	965	200	415	308	678	919	28	100	400	460	180	240	4-Ø24	290	210	683	100	600
CGH200							-										-			

■ CGL-TYPE Structure & flow direction

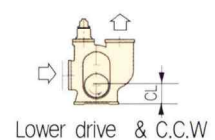
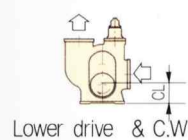
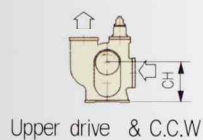
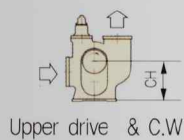

■ CGH-TYPE Structure & flow direction

